

Please email completed form to rmiller@cityofbrookings-sd.gov



520 3rd Street, Suite 140

Brookings, SD 57006

605.692.6629

www.cityofbrookings.org

COMMERCIAL CORRIDOR DESIGN REVIEW OVERLAY APPLICATION & CHECKLIST

Owner: Joshua and Briana Fiedler

Applicant: Dakota Land Design, LLC

Phone Number: 605-222-1234

Email: Kyle@DakotaLandDesign.com

Address & Legal Description: Lot 2 of Tract 1 of Fox Run Addition

Zoning District & Use: B-2

Structure Square Footage: 3996sf

Structure Height: 26' 3"

Site Plan Criteria (show on site plan)

Name of the project, owner, developer information:	<input type="checkbox"/>
Scale, north arrow, property lines/dimensions, legal description, address if known:	<input type="checkbox"/>
Location of existing and proposed structures:	<input type="checkbox"/>
Setbacks & dimensions to property lines at the closest point:	<input type="checkbox"/>
Required greenspace areas/buffers:	<input type="checkbox"/>

Show and label easements:	<input type="checkbox"/>
Access/driveway locations and dimensions, drive aisle dimensions, sidewalks, drive thru stacking areas:	<input type="checkbox"/>
Location of trash containers and enclosures:	<input type="checkbox"/>
Parking ratio, parking spaces, and dimensions:	<input type="checkbox"/>
Square footage of surfaced area not including building (used for required tree plantings):	<input type="checkbox"/>
Square footage of parking area:	<input type="checkbox"/>
Location of any docks or garage doors:	<input type="checkbox"/>
Locations, identification, and sizes of existing and proposed trees, shrubs and other vegetation:	<input type="checkbox"/>
Foundation planting along building facing right-of-way:	<input type="checkbox"/>
Location, width, and height of all earth berms, retaining walls/fencing, and signage:	<input type="checkbox"/>
Soil mix and depth for if parking lot islands are required:	<input type="checkbox"/>
Planting schedule:	<input type="checkbox"/>
Location of bicycle parking:	<input type="checkbox"/>
Location of outdoor seating areas:	<input type="checkbox"/>
Location of mechanical equipment:	<input type="checkbox"/>
Location of fences and/or walls:	<input type="checkbox"/>
Location of exterior lighting:	<input type="checkbox"/>

Architectural/Engineered Plan Criteria

Wall elevations:	<input type="checkbox"/>
Exterior materials:	<input type="checkbox"/>
Building mechanicals:	<input type="checkbox"/>
Street-facing façade window/door glazing (20%):	<input type="checkbox"/>
Garages and accessory structures:	<input type="checkbox"/>

**Signage requires separate permit*

Applicant Signature



Date

7-31-23



WEST FACADE

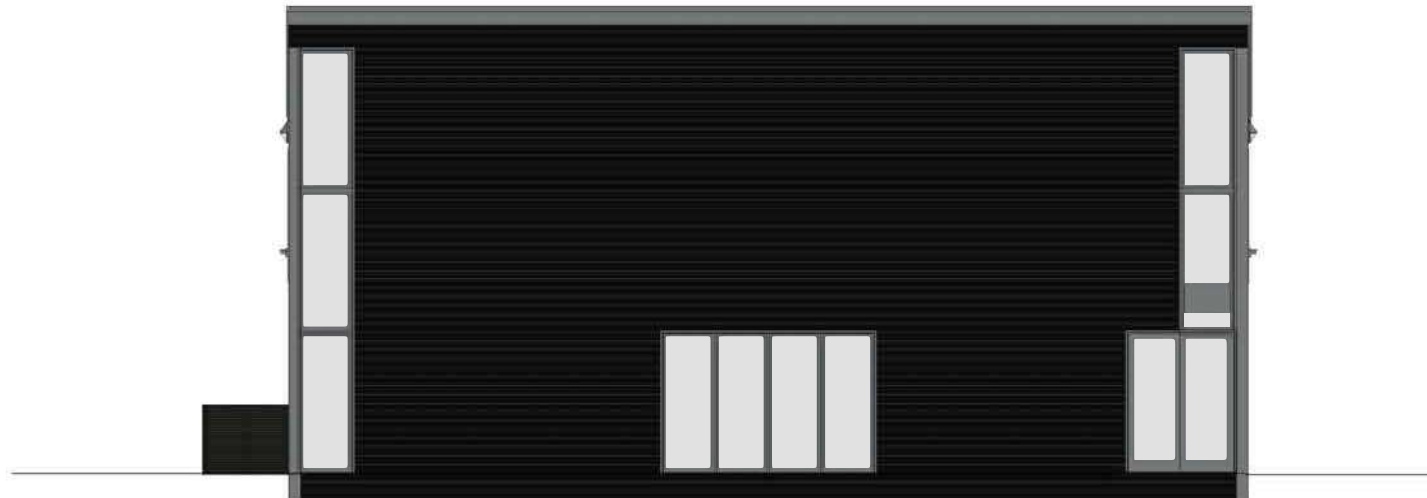

SOUTH FACADE

EXTERIOR FACADE:
LAP SIDING: LP SMART SIDE
COMMERCIAL GRADE WINDOWS
ROOFING: CERTAINTEED MOIRE BLACK

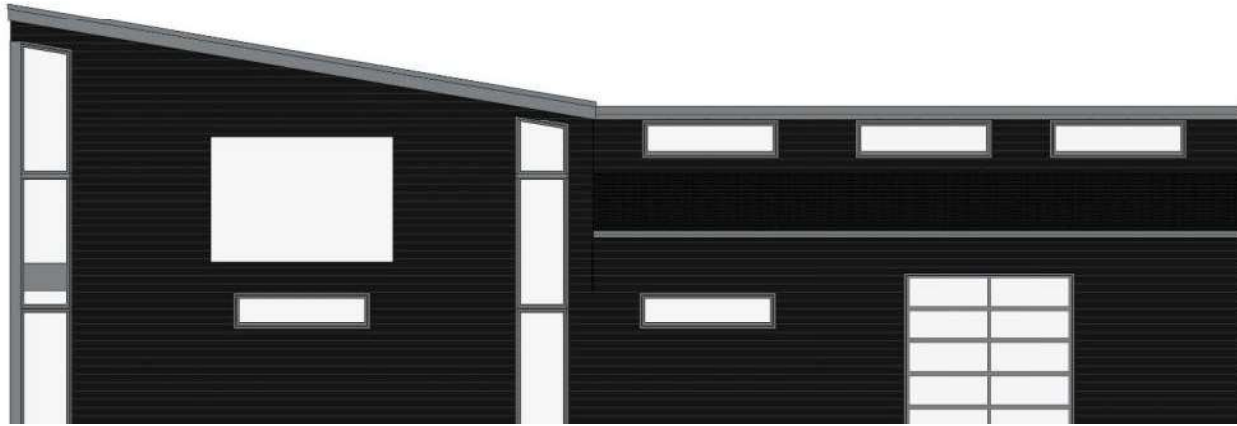

EAST FACADE (MAIN AVE) WINDOW GLAZING: 30% OF FACADE AREA

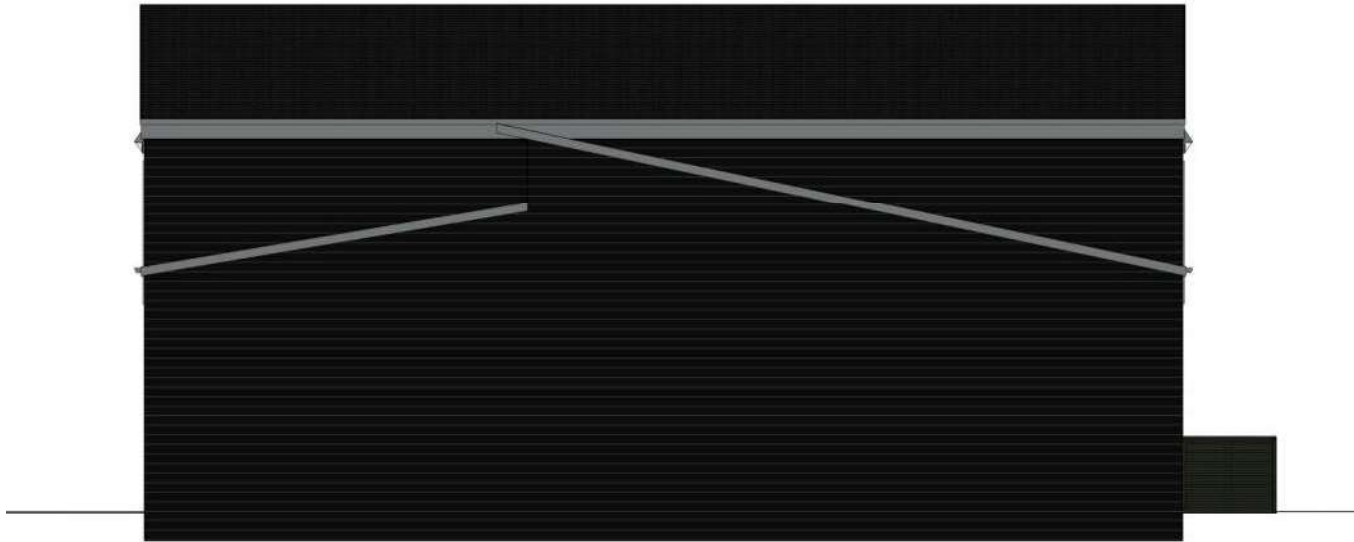

NORTH FACADE







	ITEM #:	87110/LED
	UPC	748119135984
	Description	Emode LED Sconce in Matte Black with Seeded Crystal
	Finish	Matte Black
	Materials	Aluminum, Glass
	Brand	ELK Lighting
	Collection	Emode
	Category	Outdoor Lighting
	Type	Sconce

ITEM DIMENSIONS				RATINGS & SPECIFICATIONS				
Width	4.75 inches			Safety Rating	ETL		Certification	Wet locations
Depth	2.5 inches			ADA Compliant	N/A		Voltage	120
Height	14 inches			INTEGRATED LED				
Weight	4.25 pounds			Wattage	11 watts		Total Lumens	460
ADDITIONAL DIMENSIONS				CRI	80		Color Temperature	3000K
Backplate/Canopy	4.5x13			Other	N/A			
HCWO	5 inches			CHAIN / CORD INFORMATION				
Min. Extension	N/A			Chain	N/A		Cord	8 inches
Max. Extension	N/A			SHADE / GLASS DETAILS				
OVERALL HEIGHT				Shade/Glass Description	Seeded crystal			
Min.	N/A		Max.	N/A				
EXTENSION ROD(S)				Width	2.75 inches		Height	10 inches
N/A				Width at Top	N/A		Width at Bottom	N/A

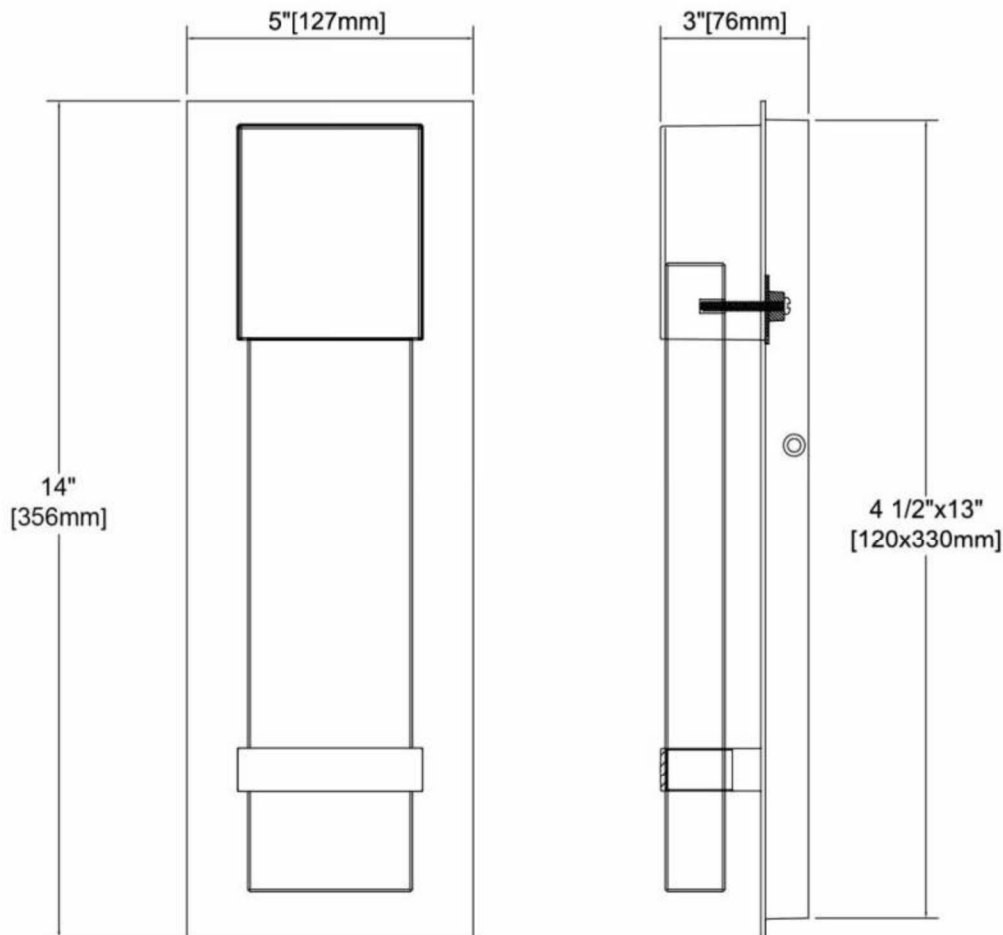

VIPER L

LARGE VIPER LUMINAIRE

FEATURES

- Large size companion to Viper Small
- Wide choice of different LED wattage configurations
- Ten optical distributions
- Designed to replace HID lighting up to 1000W MH or HPS
- Suitable for wet locations



*3000K and warmer CCTs only

See Certification Specifications

CONTROL TECHNOLOGY



SPECIFICATIONS

CONSTRUCTION

- Manufactured with die cast aluminum
- Coated with a polyester finish that meets ASTM B117 corrosion test requirements and ASTM D522 cracking and loss of adhesion test requirements
- IFS polyester powder-coat electrostatically applied and thermocured. IFS finish consists of a five stage pretreatment regimen with a polymer primer sealer and top coated with a thermoset super TGIC polyester powder coat finish
- The finish meets the AAMA 2604 performance specification which includes passing a 3,000-hour salt spray test for corrosion resistance and resists cracking or loss of adhesion per ASTM D522 and resists surface impacts of up to 160 inch-pounds
- External hardware is corrosion resistant

OPTICS

- Cartridge is held together with internal brass standoffs soldered to the board so that it can be field replaced as a one-piece optical system
- One-piece silicone gasket ensures a weatherproof seal around each individual optic
- One-piece optical cartridge system consisting of an LED engine, optics, gasket and stainless steel bezel

INSTALLATION

- Mounting options for horizontal arm, vertical tenon or traditional arm mounting available. Mounting hardware included

ELECTRICAL

- Luminaire accepts 100V through 277V, 347V or 480V input 50 Hz to 60 Hz (UNV)

ELECTRICAL (CONTINUED)

- Power factor is $\geq .90$ at full load
- Dimming drivers are standard, but CD must be selected in options to obtain external wiring leads for dimming controls
- Component-to-component wiring within the luminaire may carry no more than 80% of rated load and is certified by UL for use at 600VAC at 90°C or higher
- Plug disconnects are certified by UL for use at 600 VAC, 13A or higher. 13A rating applies to primary (AC) side only
- Fixture electrical compartment contains all LED driver components
- Optional 7-pin ANSI C136.41-2013 Twist-Lock® photo control receptacle available. Compatible with ANSI C136.41 external wireless control devices
- Ambient operating temperature -40°C to 25°C
- Surge protection: 20kA
- Lifeshield™ Circuit ([see Electrical Data](#))

CONTROLS

- Available with an optional passive infrared (PIR) motion sensor capable of detecting motion 360° around the luminaire. When no motion is detected for the specified time, the motion response system reduces the wattage to factory preset level, reducing the light level accordingly. When motion is detected by the PIR sensor, the luminaire returns to full wattage and full light output. Please contact Beacon Products if project requirements vary from standard configuration
- Available with [Energeni](#) for optional set dimming, timed dimming with simple delay, or timed dimming based on time of night

OPTICS STRIKE



RELATED PRODUCTS

[Viper Small](#)

CONTROLS (CONTINUED)

- In addition, Viper can be specified with [SiteSync™ wireless control system](#) for reduction in energy and maintenance costs while optimizing light quality 24/7

CERTIFICATIONS

- DLC® (DesignLights Consortium) Qualified. Please refer to the DLC website for specific product qualifications at www.designlights.org
- Certified to UL 1598 and UL 8750
- 3G rated for ANSI C136.31 high vibration applications with MAF mounting
- IDA approved
- This product is approved by the Florida Fish and Wildlife Conservation Commission. [Separate spec available online](#)
- This product qualifies as a “designated country construction material” per FAR 52.225-11 Buy American-Construction Materials under Trade Agreements effective 06/03/2020. See [Buy American Solutions](#).

WARRANTY

- 5 year warranty
- See [HLI Commercial and Industrial Outdoor Lighting Warranty](#) for additional information

KEY DATA	
Lumen Range	14,283–39,969
Wattage Range	64–395
Efficacy Range (LPW)	98–135
Reported Life (Hours)	L70>377,000
Input Current Range (Amps)	0.3–4.0

VIPER L

LARGE VIPER LUMINAIRE

AA: VPL-80L-180-4K7-3-UNV-A-PSS-GENI-04-BC

ORDERING GUIDE

Example: VPL-96L-280-4K7-4W-UNV-A-DBT-GENI-04-BC

 CATALOG #

VPL Series	LED Engine	CCT/CRI ⁷	Distribution	Rotation	Voltage
VPL Viper Large	64L-135 135W LED array 80L-180 180W LED array 80L-235 235W LED array 96L-220 220W LED array 96L-280 280W LED array 96L-315 315W LED array 96L-395 395W LED array	3K7 3000K, 70 CRI 4K7 4000K, 70 CRI 5K7 5000K, 70 CRI	FR Type 1/Front Row 2 Type 2 3 Type 3 4F (formerly 4) Type 4 4W Type 4 Wide 5QM Type 5QM 5QN Type 5QN 5R Type 5R (rectangular) 5W Type 5W (round wide) TC Tennis Court CR Corner Right CL Corner Left	Blank No rotation L Optic rotation left ⁵ R Optic rotation right ⁵	UNV 120-277V 347 347V 480 480V

Mounting	Color	Control Options Network	Options
A Rectangular Arm (formerly RA) for square or round pole MAF Mast Arm Fitter (formerly SF2) for 2 3/8" OD horizontal arm K Knuckle (formerly PK2) limit to 30° tilt or 2 3/8" OD horizontal arm or vertical tenon WB Wall Bracket AD Universal Arm for square pole AD3 Universal Arm with adapter for 2.4"-4.1" round pole AD4 Universal Arm with adapter for 4.2"-5.3" round pole AD5 Universal Arm with adapter for 5.5"-5.9" round pole AD6 Universal Arm with adapter for 6.0"-6.5" round pole	BLT Black Matte Textured BLS Black Gloss Smooth DBT Dark Bronze Matte Textured DBS Dark Brone Gloss Smooth GTT Graphite Matte Textured LGS Light Grey Gloss Smooth PSS Platinum Silver Smooth WHT White Matte Textured WHS White Gloss Smooth VGT Verde Green Textured Color Option CC Custom Color	NXWE NX Wireless Enabled (module + radio) NXSPW_F Nx Wireless, PIR Occ. Sensor, Daylight Harvesting ² NXSP_F NX, PIR Occ. Sensor, Daylight Harvesting ² WIR Wireless Controls, wiSCAPE Control Options 7PR 7-Pin Receptacle only (shorting cap, photo control, or wireless control provided by others) 7PR-SC 7-Pin Receptacle w/Shorting Cap 7PR-TL 7-Pin Receptacle w/Twist-Lock® photo control SCP/_F Programmable Occupancy Sensor w/ daylight control ^{1,2,6} GENI-XX ENERGENI ³ SWP SiteSync Pre-Commission ^{1,4} SWPM_F SiteSync Pre-Commission w/ Sensor ^{1,2,4}	BC Backshield (available for FR, 2, 3, 4, 4W Optics) CD Continuous Dimming F Fusing TB Terminal Block

House Side Shield Accessories

<input type="checkbox"/>	HSS/EVP-L/90-FB/XXX	90° shield front or back
<input type="checkbox"/>	HSS/EVP-L/90-LR/XXX	90° shield left or right
<input type="checkbox"/>	HSS/EVP-L/270-FB/XXX	270° shield front or back
<input type="checkbox"/>	HSS/EVP-L/270-LR/XXX	270° shield left or right
<input type="checkbox"/>	HSS/EVP-L/360/XXX	Full shield

Replace XXX with notation for desired finish color. Refer to page 8 for shield images.

Mounting Accessories

<input type="checkbox"/>	VPL-AD-RPA3	2.4"-4.1" Round Pole Adapter for AD arm
<input type="checkbox"/>	VPL-AD-RPA4	4.2"-5.3" Round Pole Adapter for AD arm
<input type="checkbox"/>	VPL-AD-RPA5	5.5"-5.9" Round Pole Adapter for AD arm
<input type="checkbox"/>	VPL-AD-RPA6	6.0"-6.5" Round Pole Adapter for AD arm

- Notes:
- Not available with other wireless control or sensor options
 - Specify mounting height; 8 = 8' or less, 40 = 14' to 40'
 - Specify routine setting code (example GENI-04). See [ENERGENI brochure and instructions](#) for setting table and options. Not available with sensor or SiteSync options
 - Specify group and zone at time of order. See www.hubbellighting.com/sitesync for further details. Order at least one SiteSync interface accessory SWUSB or SWTAB. Each option contains SiteSync License, GUI, and Bridge Node
 - Only available with FR, 2, 3, 4, 4W and 5R distributions
 - Order at least one SCP-REMOTE per project location to program and control the occupancy sensor

Accessories and Services (Ordered Separately)

<input type="checkbox"/>	SCP-REMOTE	Remote Control for SCP/_F option. Order at least one per project to program and control the occupancy sensor
<input type="checkbox"/>	SWUSB*	SiteSync interface software loaded on USB flash drive for use with owner supplied PC (Windows based only). Includes SiteSync license, software and USB radio bridge node
<input type="checkbox"/>	SWTAB*	Windows tablet and SiteSync interface software. Includes tablet with preloaded software, SiteSync license and USB radio bridge node
<input type="checkbox"/>	SWBRG	SiteSync USB radio bridge node only. Order if a replacement is required or if an extra bridge node is requested
<input type="checkbox"/>	SW7PR+	SiteSync 7-Pin on fixture module On/Off/Dim, Daylight Sensor 120-480VAC
<input type="checkbox"/>	BIRD-SPIKE-4	Bird Spikes

Hubbell Control Solutions — Accessories (Sold Separately)

NX Distributed Intelligence™	
<input type="checkbox"/>	NXOFM-1R1D-UNV On-fixture Module (7-pin), On / Off / Dim, Daylight Sensor with HubbNET Radio and Bluetooth® Radio, 120-480VAC
wiSCAPE® Lighting Control	
<input type="checkbox"/>	WIR-RME-L On-fixture Module (7-pin or 5-pin), On / Off / Dim, Daylight Sensor with wiSCAPE Radio, 110-480VAC

For additional information related to these accessories please visit www.hubbellcontrolsolutions.com. Options provided for use with integrated sensor, please view specification sheet ordering information table for details.

DATE:	LOCATION:
TYPE:	PROJECT:
CATALOG #:	

VIPER L

LARGE VIPER LUMINAIRE

CONTROLS

SiteSync — Precommissioned Ordering Information:

When ordering a fixture with the SiteSync lighting control option, additional information will be required to complete the order. The SiteSync Commissioning Form or alternate schedule information must be completed. This form includes Project location, Group information, and Operating schedules. For more detailed information please visit [the SiteSync family page on our website](#) or contact Hubbell Lighting tech support at 800-888-8006.



SiteSync fixtures with Motion control (SWPM) require the mounting height of the fixture for selection of the lens.

Examples: VP-L/80L-235/4K7/3/UNV/A/DB/SWP/ SiteSync only
 VP-L/80L-235/4K7/3/UNV/A/DB/SWPM-40F/ SiteSync with Motion Control

SiteSync 7-Pin Module:

- SiteSync features in a new form
- Available as an accessory for new construction or retrofit applications (with existing 7-Pin receptacle)
- Does not interface with occupancy sensors



SW7PR

NX Distributed Intelligence™ Lighting Controls:

Supports both indoor and outdoor applications in a variety of deployment options: wired, wireless and hybrid. Integrates with and enables a wide array of luminaires including those with SpectraSync Color Tuning Technology.



NX Integrated Controls Reference								
NX Option	Sensor	Networkable	Scheduling	Occupancy	Daylight Harvesting	0–10V Dimming	On/off Control	Bluetooth® App Programming
NX Networked – Wireless								
NXOFM-1R1D-UNV	SCLNX	Yes	Yes	Yes	Yes	Yes	Yes	Yes, Bluetooth App

wiSCAPE™:

Supports remote management, monitoring and metering of outdoor wireless lighting applications such as smart campuses, smart cities, parking lots, parking lots and roadways.



wiSCAPE Reference								
wiSCAPE Option	Sensor	Networkable	Scheduling	Occupancy	Daylight Harvesting	0–10V Dimming	On/off Control	Bluetooth® App Programming
Networked – Wireless								
WIR-RME-L	WIR-RME-L	Yes	Yes	No	Yes	Yes	Yes	wiSCAPE Gateway

VIPER L

LARGE VIPER LUMINAIRE

DELIVERED LUMENS

# of LEDs	DRIVE CURRENT (mA)	SYSTEM WATTS	DISTRIBUTION TYPE	5K (5000K nominal, 70 CRI)					4K (4000K nominal, 70 CRI)					3K (3000K nominal, 70 CRI)				
				LUMENS	LPW ¹	B	U	G	LUMENS	LPW ¹	B	U	G	LUMENS	LPW ¹	B	U	G
64	625 mA	135W	1A	18220	132	2	0	2	18783	137	2	0	2	16341	119	2	0	2
			2	17228	125	2	0	2	17761	129	2	0	2	15452	112	2	0	2
			3	17257	125	2	0	3	17791	129	2	0	3	15478	112	2	0	3
			4	16864	123	1	0	4	17386	126	1	0	4	15125	110	1	0	3
			4W	15106	112	2	0	4	15573	115	2	0	4	13237	98	2	0	3
			5QM	17259	125	4	0	2	17792	129	4	0	2	15479	112	4	0	2
			5QN	18023	131	4	0	0	18580	135	4	0	0	16165	117	4	0	0
			5R	17410	127	4	0	4	17948	130	4	0	4	15615	113	4	0	4
			5W	16498	120	4	0	2	17009	124	4	0	3	14797	108	4	0	2
			TC	15925	110	2	1	2	16417	113	2	1	2	14283	98	1	1	2
			CL	17350	128	3	0	3	17886	132	3	0	3	15561	114	2	0	3
			CR	17407	128	3	0	3	17945	132	3	0	3	15612	115	2	0	3
			80	700 mA	180W	1A	23230	128	2	0	2	23948	132	2	0	2	20835	115
2	21965	121				3	0	3	22645	125	3	0	3	19701	109	2	0	3
AA 3	22003	121				2	0	4	22683	125	3	0	4	19734	109	2	0	4
4	21502	119				2	0	4	22167	122	2	0	4	19285	106	2	0	4
4W	19260	107				2	0	4	19856	110	2	0	4	16877	94	2	0	4
5QM	22005	121				4	0	2	22686	125	4	0	2	19736	109	4	0	2
5QN	22979	127				4	0	1	23689	131	4	0	1	20610	114	4	0	0
5R	22197	122				4	0	4	22884	126	4	0	4	19909	110	4	0	4
5W	21035	116				5	0	3	21686	120	5	0	3	18867	104	4	0	3
TC	19906	110				2	1	2	20522	113	2	1	2	17854	98	2	1	2
CL	22121	123				3	0	4	22805	127	3	0	4	19840	110	3	0	4
CR	22193	123				3	0	4	22879	127	3	0	4	19905	111	3	0	4
80	875 mA	235W				1A	27849	121	2	0	2	28711	125	2	0	2	24978	108
			2	26334	114	3	0	3	27148	118	3	0	4	23619	102	3	0	3
			3	26378	114	3	0	4	27194	118	3	0	4	23659	103	3	0	4
			4	25777	112	2	0	4	26575	115	2	0	5	23120	100	2	0	4
			4W	23090	98	2	0	5	23805	101	2	0	5	20234	86	2	0	4
			5QM	26381	114	4	0	2	27196	118	4	0	2	23661	103	4	0	2
			5QN	27548	119	5	0	1	28400	123	5	0	1	24708	107	5	0	1
			5R	26611	115	5	0	5	27434	119	5	0	5	23868	104	4	0	4
			5W	25218	109	5	0	3	25998	113	5	0	3	22619	98	5	0	3
			TC	23864	103	2	1	2	24602	107	2	1	2	21404	93	2	1	2
			CL	26520	113	3	0	4	27340	116	3	0	4	23786	101	3	0	4
			CR	26606	113	3	0	4	27429	117	3	0	4	23864	102	3	0	4
			96	700 mA	220W	1A	27876	128	2	0	2	28738	132	2	0	2	25002	115
2	26359	121				3	0	3	27174	125	3	0	4	23641	109	3	0	3
3	26403	121				3	0	4	27220	125	3	0	4	23681	109	3	0	4
4	25802	119				2	0	4	26600	122	2	0	5	23142	106	2	0	4
4W	23111	105				2	0	5	23826	108	2	0	5	20252	92	2	0	4
5QM	26406	121				4	0	2	27222	125	4	0	2	23684	109	4	0	2
5QN	27575	127				5	0	1	28427	131	5	0	1	24732	114	5	0	1
5R	26637	122				5	0	5	27460	126	5	0	5	23891	110	4	0	4
5W	25242	116				5	0	3	26023	120	5	0	3	22640	104	5	0	3
TC	23887	110				2	1	2	24626	113	2	1	2	21424	98	2	1	2
CL	26545	121				3	0	4	27366	124	3	0	4	23809	108	3	0	4
CR	26632	121				3	0	4	27456	125	3	0	4	23886	109	3	0	4
96	875 mA	280W				1A	33419	121	3	0	2	34453	125	3	0	2	29974	108
			2	31600	114	3	0	4	32577	118	3	0	4	28342	102	3	0	4
			3	31654	114	3	0	5	32633	118	3	0	5	28390	103	3	0	4
			4	30933	112	2	0	5	31889	115	2	0	5	27744	100	2	0	5
			4W	27708	99	3	0	5	28564	102	3	0	5	24280	87	2	0	5
			5QM	31657	114	5	0	3	32636	118	5	0	3	28393	103	4	0	2
			5QN	33058	119	5	0	1	34080	123	5	0	1	29650	101	5	0	1
			5R	31933	115	5	0	5	32921	119	5	0	5	28641	104	5	0	5
			5W	30262	109	5	0	4	31198	113	5	0	4	27142	98	5	0	3
			TC	28642	104	2	1	3	29528	107	2	1	3	25690	93	2	1	2
			CL	31824	106	3	0	5	32808	110	3	0	5	28543	95	3	0	4
			CR	31928	107	3	0	5	32915	110	3	0	5	28636	96	3	0	4
			96	1000mA	315W ²	1A	35666	113	3	0	2	36769	117	3	0	2	31989	101
2	33725	107				3	0	4	34768	110	3	0	4	30248	96	3	0	4
3	33782	107				3	0	5	34827	110	3	0	5	30299	96	3	0	4
4	33012	105				2	0	5	34033	108	2	0	5	29609	94	2	0	5
4W	29571	94				3	0	5	30485	97	3	0	5	25913	82	2	0	5
5QM	33785	107				5	0	3	34830	110	5	0	3	30302	96	5	0	2
5QN	35280	112				5	0	1	36371	115	5	0	1	31643	100	5	0	1
5R	34080	108				5	0	5	35134	111	5	0	5	30567	97	5	0	5
5W	32302	102				5	0	4	33301	106	5	0	4	28972	92	5	0	4
TC	30568	97				2	1	3	31513	100	3	1	3	27416	87	2	1	3
CL	33964	107				3	0	5	35014	111	3	0	5	30462	96	3	0	5
CR	34074	108				3	0	5	35128	111	3	0	5	30561	97	3	0	5

96 LED continues on page 4

- Lumen values are from photometric tests performed in accordance with IESNA LM-79-08. Data is considered to be representative of the configurations shown. Actual performance may differ as a result of end-user environment and application.
- 315W and 395W 3000K versions are not DLC QPL listed. Reference dark gray highlighted cells in table.

VIPER L

LARGE VIPER LUMINAIRE

DELIVERED LUMENS

# of LEDs	DRIVE CURRENT (mA)	SYSTEM WATTS	DISTRIBUTION TYPE	5K (5000K nominal, 70 CRI)					4K (4000K nominal, 70 CRI)					3K (3000K nominal, 70 CRI)				
				LUMENS	LPW ¹	B	U	G	LUMENS	LPW ¹	B	U	G	LUMENS	LPW ¹	B	U	G
96	1225mA	395W ²	1A	39569	101	3	0	4	43125	110	3	0	3	37518	96	3	0	2
			2	39569	101	3	0	4	40793	104	3	0	4	35490	91	3	0	4
			3	39619	101	3	0	5	40845	104	3	0	5	35535	91	3	0	5
			4	38723	98	3	0	5	39921	101	3	0	5	34731	88	2	0	5
			4W	34691	86	3	0	5	35764	89	3	0	5	30400	76	3	0	5
			5QM	39623	101	5	0	3	40848	104	5	0	3	35538	90	5	0	3
			5QN	41394	105	5	0	1	42675	109	5	0	1	37127	95	5	0	1
			5R	39969	102	5	0	5	41205	105	5	0	5	35848	91	5	0	5
			5W	37877	97	5	0	4	39048	100	5	0	4	33986	87	5	0	4
			TC	35850	90	3	1	3	36959	93	3	1	3	32154	81	3	1	3
			CL	39834	100	3	0	5	41066	103	4	0	5	35727	90	3	0	5
			CR	39964	101	3	0	5	41200	104	4	0	5	35844	90	3	0	5

- 1 Lumens values are from photometric tests performed in accordance with IESNA LM-79-08. Data is considered to be representative of the configurations shown. Actual performance may differ as a result of end-user environment and application.
- 2 315W and 395W 3000K versions are not DLC QPL listed. Reference dark gray highlighted cells in table.

DIMENSIONS

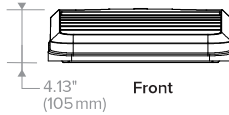
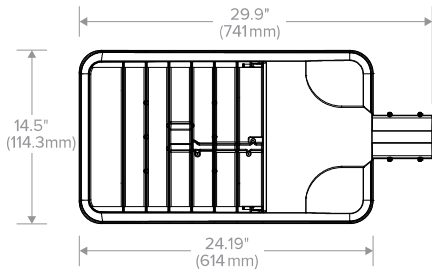

Weight	25.0 lbs (11.3 kg)
EPA	1.2 ft ²

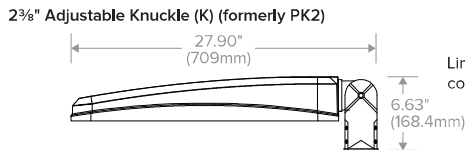
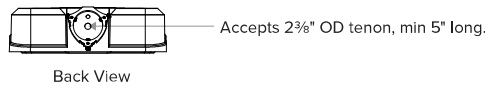
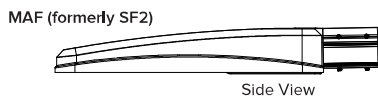
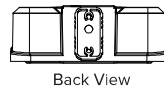

Limit to 30° tilt. Sensor, photocells and wireless controls should not be tilted above horizontal.

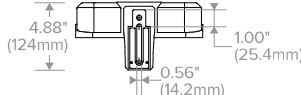
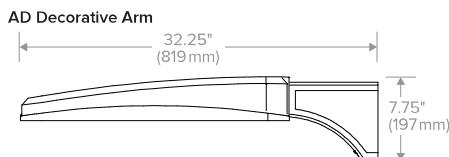
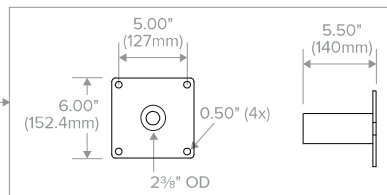
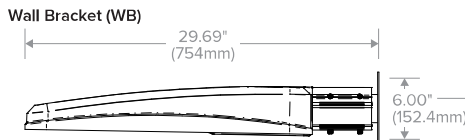

See page 9 for mounting details.

VIPER L

LARGE VIPER LUMINAIRE

PHOTOMETRY

The following diagrams represent the general distribution options offered for this product. For detailed information on specific product configurations, see [website photometric test reports](#).

Type FR – Front Row/Auto Optic

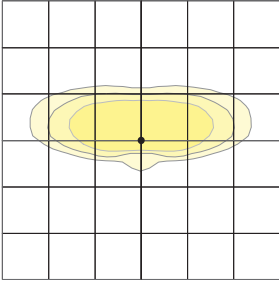

Type 2

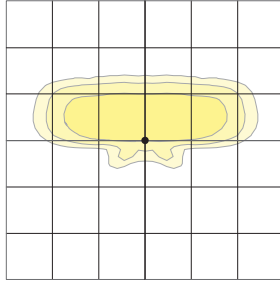

Type 3

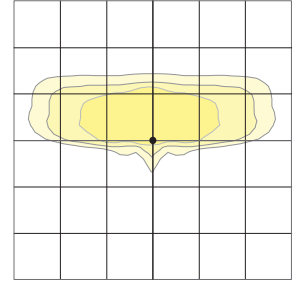

Type 4

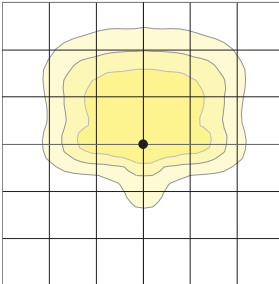

Type 4 Wide

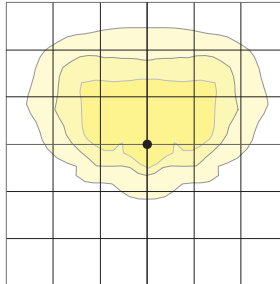

Type 5QM

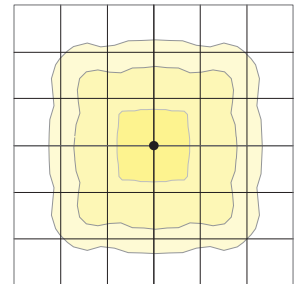

Type 5QN

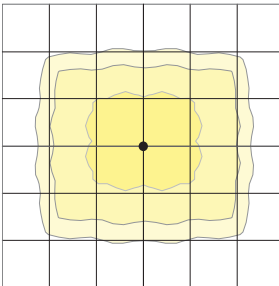

Type 5R (rectangular)

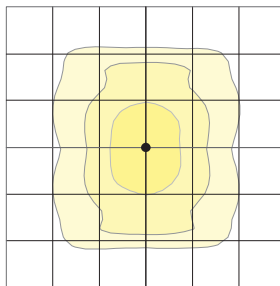

Type 5W (round wide)

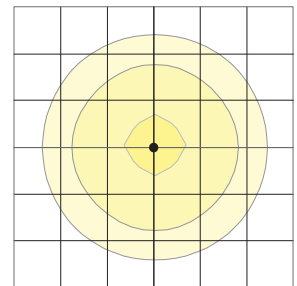

Type TC

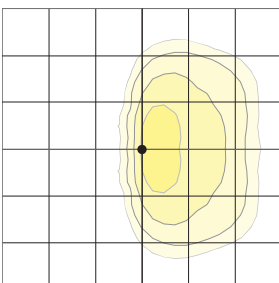

VIPER L

LARGE VIPER LUMINAIRE

ELECTRICAL DATA

# OF LEDs	NUMBER OF DRIVERS	DRIVE CURRENT (mA)	INPUT VOLTAGE (V)	SYSTEM POWER (w)	CURRENT (Amps)
64	1	625 mA	120	135	1.4
			277		0.6
			347		0.5
			480		0.3
80	2	700 mA	120	180	1.8
			277		0.8
			347		0.6
			480		0.5
80	2	875 mA	120	235	2.4
			277		1
			347		0.8
			480		0.6
96	2	700 mA	120	220	2.2
			277		1
			347		0.8
			480		0.6
96	2	875 mA	120	280	2.8
			277		1.2
			347		1
			480		0.7
96	2	1000 mA	120	315	3.2
			277		1.4
			347		1.1
			480		0.8
96	2	1225 mA	120	395	4
			277		1.7
			347		1.4
			480		1

PROJECTED LUMEN MAINTENANCE						
Ambient Temp.	0	25,000	50,000	TM-21-11 60,000 ¹	100,000	Calculated L70 (HOURS)
25°C / 77°C	1	0.98	0.97	0.97	0.96	>377,000

¹ Projected per IESNA TM-21-11.
Data references the extrapolated performance projections for the 700mA base model in a 25°C ambient, based on 10,000 hours of LED testing per IESNA LM-80-08.

LIFESHIELD™ CIRCUIT

Protects luminaire from excessive temperature. The device activates at a specific, factory-preset temperature and progressively reduces power over a finite temperature range. Operation is smooth and undetectable to the eye. Thermal circuit is designed to “fail on”, allowing the luminaire to revert to full power in the event of an interruption of its power supply or faulty wiring connection to the drivers. The device can co-exist with other 0–10V control devices (occupancy sensors, external dimmers, etc.)

ADDITIONAL INFORMATION

ROTATION OPTIONS

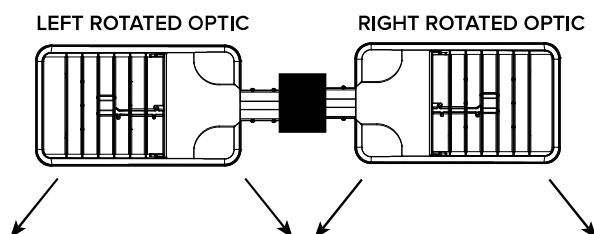

VIPER L

LARGE VIPER LUMINAIRE

ADDITIONAL INFORMATION (CONTINUED)

DRILL PATTERN

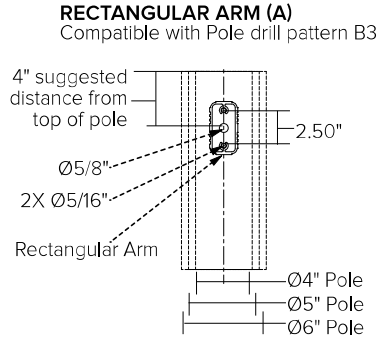

EPA

Config.	EPA
1	1.2
2 @ 90°	1.9
2 @ 180°	2.4

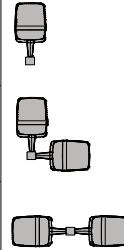

Config.	EPA
3 @ 120°	3.0
3 @ 90°	3.1
4 @ 90°	3.8

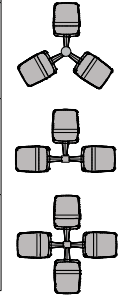

TENON TOP POLE BRACKET ACCESSORIES (ORDER SEPARATELY)

(2 3/8" OD tenon)

TENON TOP POLE BRACKET ACCESSORIES (Order Separately)

- SETAVP-XX** Square tenon adapter (4 at 90°) for A - Rectangular Arm mounting option only
- RETAVP-XX** Round tenon adapter (4 at 90°) for A - Rectangular Arm mounting option only
- SETA2XX** Square tenon adapter (4 at 90°) for AD - Universal Arm mounting option only
- RETA2XX** Round tenon adapter (4 at 90°) for AD3 - Universal Arm mounting option only

HOUSE SIDE SHIELD FIELD INSTALL ACCESSORIES

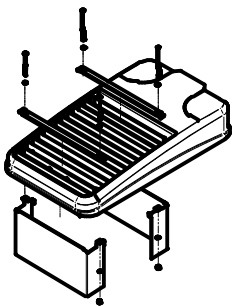

HSS/VP-L/90-FB/XXX
90° shield front or back
(2 shields shown)

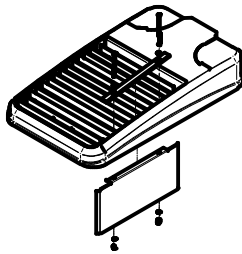

HSS/VP-L/90-LR/XXX
90° shield left or right
(1 shield shown in left orientation)

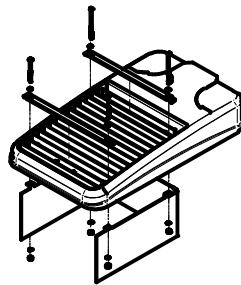

HSS/VP-L/270-FB/XXX
270° shield front or back
(1 shield shown in back orientation)

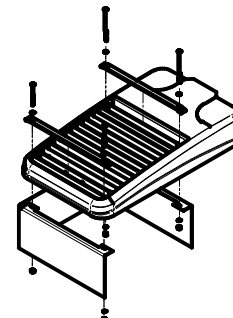

HSS/VP-L/270-LR/XXX
270° shield left or right
(1 shield shown in right orientation)

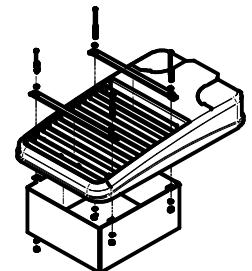

HSS/VP-L/360/XXX
Full shield
(1 shield shown)

VIPER L

LARGE VIPER LUMINAIRE

ADDITIONAL INFORMATION (CONTINUED)

AD ARM MOUNTING INSTRUCTIONS

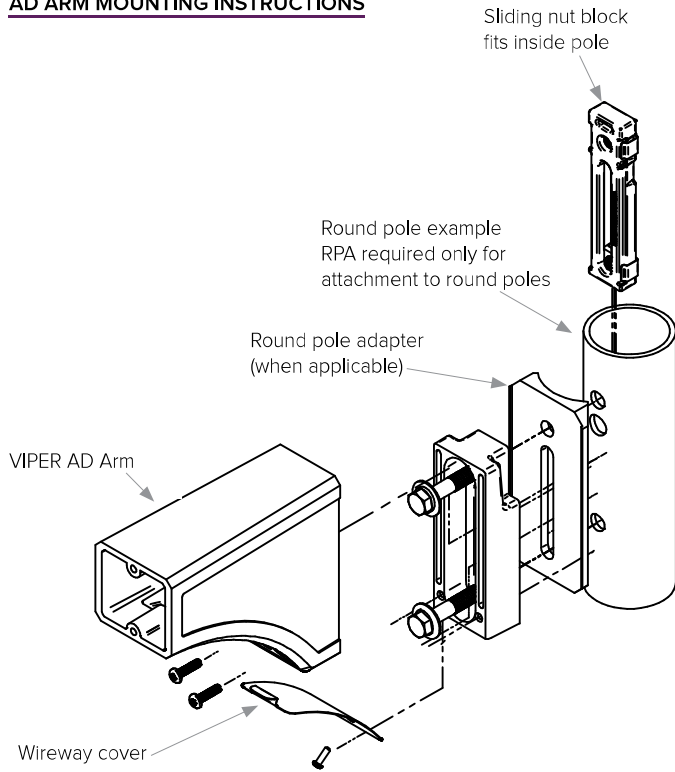

DECORATIVE ARM (AD)

Compatible with pole drill pattern S2

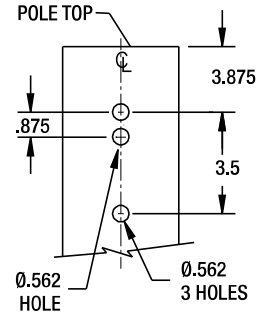

USE OF TRADEMARKS AND TRADE NAMES

All product and company names, logos and product identifies are trademarks™ or registered trademarks® of Hubbell Lighting, Inc. or their respective owners. Use of them does not necessarily imply any affiliation with or endorsement by such respective owners.

DESCRIPTION

6 inch LED recessed narrow, medium, or wide beam downlight designed for glare free even illumination. Featuring a two-stage diffused reflector system producing smooth distribution with excellent light control and low aperture brightness. Lumen packages range from 1000 to 7000 with color temperatures of 2400K, 2700K, 3000K, 3500K, 4000K, and 5000K. VividTune: Dim-to-warm technology – similar to halogen at full power, the 3000K LED warms smoothly as dimmed to 1850K creating a rich warm glow within the space. Tunable white technology - adjust the color temperature from warm white to cool white while independently controlling intensity.

Catalog #		Type
Project		CC
Comments		Date
Prepared by		

SPECIFICATION FEATURES

Lower Shielding Reflector

Painted die cast aluminum or spun aluminum lower reflector with a lensed upper optical chamber providing superior lumen output with minimal source brightness. Spun reflectors are offered in all Portfolio Alzak® finishes. Available with non-conductive polymer trim. Reflector is retained with two torsion springs holding the flange tight to the finished ceiling surface.

Plaster Frame / Collar

Die cast aluminum 1-1/2" deep collar accommodates ceiling materials up to 2". Universal mounting bracket accepts 1/2" EMT, C channel and bar hangers and adjusts 5" vertically from above and below the ceiling.

Junction Box

Listed for (8) #12 AWG (four in, four out) 90°C conductors and feed thru branch wiring. (4) 1/2" and (2) 3/4" trade size pry outs positioned to allow straight conduit runs. Lever connectors for simple push in wiring.

Thermal

Aluminum heat sink conducts heat away from the LED module for optimal performance and long life.

LED

Chip on board with a multitude of highly efficient white LED's, combined with a high reflectance upper reflector and convex transitional lens produce even distribution with no pixilation. Rated for 50,000 hours at 70% lumen maintenance. Auto resetting, thermally protected, LED's are turned off when safe operating temperatures are exceeded. Color variation within 3-step MacAdam ellipses. Quick disconnect allows for tool-less replacement of LED engine from below ceiling. Available in 80, 90 or 97 CRI.

D2W™ – dim-to-warm shifts CCT from 3000K to 1850K as fixture dims mimicking halogen sources.

W2N - Tunable white CCT range 2700K to 6500K or 2000K to 5000K, 90 CRI.

Driver

Standard 120-277V 0-10V dimming driver provides flicker free dimming from 100% to 1% (offered up to 4000 lumens). Optional 120V leading edge, <1% 0-10V, Fifth Light, DMX or Lutron® Ecosystem. Driver can be serviced from above or through the aperture.

Connected Lighting Systems

WaveLinX tilemount daylight sensor includes control module, sensor and cable allowing use with the comprehensive lighting system. LumaWatt Pro (powered by Enlighted) wireless tile mount sensor and relay accessory enables wireless control using a tile mount sensor accessory. Distributed low voltage power system combines power, lighting, and controls with ease of installation.

Code Compliance

Thermally protected and cULus listed for wet locations with covered ceiling. IP66 rated when used with IP66 gasket kit accessory. Optional City of Chicago environmental air (CCEA) marking for plenum applications. EMI/RFI emissions per FCC 47CFR Part 18 Class B consumer limits. Non-IC rated - Insulation must be kept 3" from top and sides of housing. IC rated up to 1500 lumens. 5000 lumen and above are marked spacing and must follow spacing requirements. RoHS Compliant. Photometric testing completed in accordance with IES LM 79 and TM-30 standards. LED life testing completed in accordance with LM 80 standards.

Warranty

5-year warranty



**LD6B EU6B
6LBW 6LBM
6LBN**

1000 - 7000 lumens LED

Die cast or Spun Aluminum
Narrow, Medium, or Wide Beam
Reflector
New Construction

VividTune™
color tuning solutions

D2W™



Refer to ENERGY STAR® Qualified Products List. Can be used to comply with California Title 24 High Efficacy requirements.

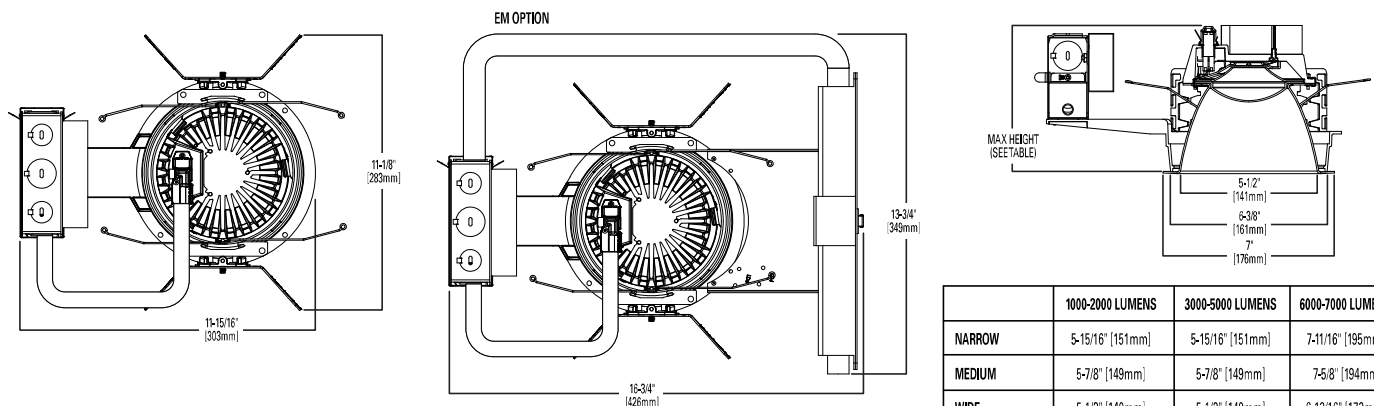

	1000-2000 LUMENS	3000-5000 LUMENS	6000-7000 LUMENS
NARROW	5-15/16" [151mm]	5-15/16" [151mm]	7-11/16" [195mm]
MEDIUM	5-7/8" [149mm]	5-7/8" [149mm]	7-5/8" [194mm]
WIDE	5-1/2" [140mm]	5-1/2" [140mm]	6-13/16" [173mm]
SHALLOW TRIM	5-1/2" [140mm]	5-1/2" [140mm]	NA

ORDERING INFORMATION

SAMPLE NUMBER: LD6B15D010EMBOD

LD6B20D010-EU6B10208040-6LBW1WMH

Housing	Lumens ¹	Voltage	Driver	Options ³
LD6B =LED Downlight 6" Nominal Aperture LD6BCP =LED Downlight 6" Nominal Aperture, Chicago Plenum	10 =1000 lumens 15 =1500 lumens 20=2000 lumens 30 =3000 lumens 40 =4000 lumens 50 =5000 lumens ¹⁰ 60 =6000 lumens ¹⁰ 70 =7000 lumens ¹⁰	Blank=120-277V 3=347V (step down transformer)	1000 - 4000 Lumen D010=0-10V Dimming, 1% to 100%, 120V-277V D010TR=0-10V or Line Voltage Dimming, 5% to 100%, 120V-277V DE010=0-10V Linear Dimming, 0% to 100%, 120V-277V D5LT=Fifth Light® (DALI) Logarithmic Dimming, 0% to 100%, 120V-277V DMX=DMX/RDM Logarithmic Dimming, 0% to 100%, 120V-277V¹⁴ DL2=Lutron® Hi-Lume Forward Phase Dimming, 1% to 100%, 120V Only DLE=Lutron Ecosystem dimming 1% to 100%, 120V-277V 5000, 6000, and 7000 Lumen D010TE=0-10V 1% or Trailing Edge, 10% to 100%, 120V-277V (120V Only for Trailing Edge Dimming) 1000 - 3000 Lumen DLV=Low voltage dimming driver (1-100%) for use with DLVP system (3000 lumen and below)^{3,15} Tunable white 1000-2000 Lumens¹⁶ 1DE010W2N2050=0-10V dimming, 0% to 100%, 120V, 2000K - 5000K 1DE010W2N2765=0-10V dimming, 0% to 100%, 120V, 2700K - 6500K 1D5LTW2N2050=Fifth Light (DALI), 0% to 100%, 120, 2000K - 5000K 1D5LTW2N2765=Fifth Light (DALI), 0% to 100%, 120V, 2700K - 6500K 2DE010W2N2050=0-10V dimming, 0% to 100%, 277V, 2000K - 5000K 2DE010W2N2765=0-10V dimming, 0% to 100%, 277V, 2700K - 6500K 2D5LTW2N2050=Fifth Light (DALI), 0% to 100%, 277V, 2000K - 5000K 2D5LTW2N2765=Fifth Light (DALI), 0% to 100%, 277V, 2700K - 6500K	EMBOD =Bodine® Emergency Module with Remote Test Switch EM7 =7W Emergency Module with Remote Test Switch EM14 =14W Emergency Module with Remote Test Switch IEMBOD =Bodine® Emergency Module with Integral Test Switch IEM7 =7W Emergency Module with Integral Test Switch IEM14 =14W Emergency Module with Integral Test Switch EMV7 =7W Low Voltage Emergency Module with Remote Test Switch ⁴ EMV14 =14W Low Voltage Emergency Module with Remote Test Switch ⁴ IEMV7 =7W Low Voltage Emergency Module with Integral Test Switch ⁴ IEMV14 =14W Low Voltage Emergency Module with Integral Test Switch ⁴ SWPD1 =Factory installed WaveLinX tilemount daylight sensor (includes control module, sensor, cable, and tile mount) LWTPD1 =Factory installed LumaWatt Pro wireless sensor kit

SAMPLE NUMBER: EU6B10208035

Power Module	Lumen Levels ¹	CRI	Color
EU6B =6" Universal LED Module	1020 =1000, 1500, 2000 lumens 3050 =3000, 4000, 5000 lumens 6070 =6000, 7000 lumens 1015IC =1000, 1500 lumen IC rated	80 =80 CRI Minimum 90 =90 CRI Minimum 97 =97 CRI Minimum	80 CRI 27 =2700K 30 =3000K 35 =3500K 40=4000K 50 =5000K 90 CRI 24 =2400K 27 =2700K 30 =3000K 35 =3500K 40 =4000K 50 =5000K 97 CRI 27 =2700K 30 =3000K
	Dim 2 Warm 109030D2W =1000 lumen, 90 CRI, Dim 2 Warm, IC rated 159030D2W =1500 lumen, 90 CRI, Dim 2 Warm, IC rated 209030D2W =2000 lumen, 90 CRI, Dim 2 Warm 309030D2W =3000 lumen, 90 CRI, Dim 2 Warm		Tunable white¹⁶ 1020W2N902050 =1000, 1500, 2000 lumens, 90 CRI, tunable white 2000K-5000K 1020W2N902765 =1000, 1500, 2000 lumens, 90 CRI, tunable white 2700K-6500K

SAMPLE NUMBER: 6LBM1LIE

Trim	Distribution ⁵	Flange	Finish	Options
6LB =6" LED	N =Narrow (30° Beam), Spun Aluminum M =Medium (50° Beam), Spun Aluminum W =Wide (75° Beam), Spun Aluminum S =Shallow (75° Beam), Spun Aluminum ¹² PS =Non-Conductive Shallow (75° Beam), Injection Molded white, non-conductive ^{11, 12} CS =Cast Shallow (90° Beam), Die Cast Aluminum BA =Baffle (50° Beam), Spun Aluminum ⁷	0 =White Polymer Trim Ring 1=Self-flanged¹³ 2 =White Painted Self-flanged	LI =Specular Clear ⁹ H =Semi-Specular Clear ⁹ WMH =Warm Haze ⁹ WH =Wheat ⁹ GPH =Graphite Haze ⁹	B =Specular Black ⁹ MW =Matte White MB =Matte Black ⁸ MMS =Matte Metallic Silver ⁸ E =Integral Emergency Test Switch Hole ⁶

Accessories

HSA6=Slope Adapter for 6" Aperture Housings, Specify Slope
TRM6=Metal Trim Ring, Specify Color²
TRR6=Rimless Trim Ring for Flush Mount²
PRR6=Plaster Lathing Ring²
LGSKT6IP66=IP66 Gasket Kit
DT6=Deco Trim²

Bar Hangers

HB26=C-channel Bar Hanger, 26" Long, Pair
HB50=C-channel Bar Hanger, 50" Long, Pair
RMB22=Wood Joist Bar Hanger, 22" Long, Pair

Transformers

H347=347 to 120V Step Down Transformer, 75VA
H347200=347 to 120V Step Down Transformer, 200VA

Connected Lighting Systems

PORLWTPD1=LumaWatt Pro wireless sensor kit (0-10V only) field installed¹⁵
TMSWPD1=WaveLinX tilemount daylight sensor (includes control module, sensor, cable and tile mount) field installed¹⁵

Notes:

- Nominal Lumens will vary depending on selected color, driver and reflector finish.
- Order trim with polymer trim ring (Consult specification sheet for color ordering information and options).
- Not available with Chicago Plenum.
- ULus listed only
- Beam angles are nominal with LI finish trims.
- Only available with Narrow and Medium Spun Aluminum trims. Required for use with all IEMBOD, IEM7, IEM14, IEMV7 and IEMV14 housings.
- Only available with Matte White and Matte Black Finishes.
- Available only on CS distributions.
- Not available on PS, CS or BA distributions.
- Product is marked spacing and must be installed with the following minimum spacing.
 - Center to center of adjacent luminaires: 36"
 - Center of luminaire to side of building member: 18"
 - Minimum overhead: 1/2"
 - Not available with CS or PS trims
- PS available in self-flanged MW finish only.
- Offered up to 2000 lumens
- Flange is the same finish as the reflector
- DMX fixtures default to full on upon loss of DMX signal.
- Refer to system specifications for additional information, features, and benefits. Order either factory installed option or accessory. Use with 0-10V driver.
- Non-IC

ENERGY

ENERGY DATA
Sound Rating: Class A standards
(Values at non-dimming line voltage)
Minimum Starting Temperature: -30°C (-22°F)
EMI/RFI: FCC Title 47 CFR, Part 15, Class B (Consumer)
Input Voltage: UNV (120V - 277V)
Power Factor: >0.90 (at nominal input 120-277 VAC & 100% of Rated Output Power)
Input Frequency: 50/60Hz

1000 Lumen D010		1500 Lumen D010	
Input Power: 11W	THD: <14%	Input Power: 15.5W	THD: <13%
120V Input Current: 0.09A	277V Input Current: 0.04A	120V Input Current: 0.13A	277V Input Current: 0.06A
2000 Lumen D010		3000 Lumen D010	
Input Power: 21.2W	THD: <9%	Input Power: 27.6W	THD: <10%
120V Input Current: 0.18A	277V Input Current: 0.08A	120V Input Current: 0.23A	277V Input Current: 0.10A
4000 Lumen D010		5000 Lumen D010TE	
Input Power: 41.6W	THD: <13%	Input Power: 57.8W	THD: <14%
120V Input Current: 0.35A	277V Input Current: 0.15A	120V Input Current: 0.49A	277V Input Current: 0.22A
6000 Lumen D010TE		7000 Lumen D010TE	
Input Power: 59.7W	THD: <14%	Input Power: 75.8W	THD: <13%
120V Input Current: 0.50A	277V Input Current: 0.22A	120V Input Current: 0.64A	277V Input Current: 0.29A

Lumens	120V		277V	
	Inrush (A)	Duration (ms)	Inrush (A)	Duration (ms)
1000 Lumen D010	1.02	0.041	2.18	0.021
1500 Lumen D010	1.02	0.042	2.24	0.064
2000 Lumen D010	1.02	0.077	2.43	0.027
3000 Lumen D010	1.15	0.067	3.26	0.027
4000 Lumen D010	1.2	0.088	3.9	0.03
5000 Lumen D010TE	5.1	0.132	10.2	0.153
6000 Lumen D010TE	5.4	0.123	10.8	0.154
7000 Lumen D010TE	4.9	0.13	9.8	0.156

PHOTOMETRY

NARROW (30° BEAM)		CANDLEPOWER DISTRIBUTION		CONE OF LIGHT		CANDELA TABLE		ZONAL LUMEN SUMMARY			LUMINANCE	
Test Number	P201217					Degrees Vertical	Canдела	Zone	Lumens	% Fixture	Average Candela Degrees	Average 0° Luminance
Housing	LD6B15D010					0	2709	0-30	960	80.4	45	677
Module	EU6B10208035					5	2526	0-40	1149	96.2	55	76
Trim	6LBN1LI					15	1468	0-60	1193	99.9	65	26
Lumens	1195					25	708	0-90	1195	100	75	0
Efficacy	83.6 Lm/W	35	299	90-180	0	0	85	0				
SC	0.53	45	44	0-180	1195	100						
				D	FC	L	W					
		5.5'	90	2.8	2.8							
		7'	55	3.6	3.6							
		8'	42	4.2	4.2							
		9'	33	4.6	4.6							
10'	27	5.2	5.2									
12'	19	6.2	6.2									

MEDIUM (50° BEAM)		CANDLEPOWER DISTRIBUTION		CONE OF LIGHT		CANDELA TABLE		ZONAL LUMEN SUMMARY			LUMINANCE	
Test Number	P201215					Degrees Vertical	Canдела	Zone	Lumens	% Fixture	Average Candela Degrees	Average 0° Luminance
Housing	LD6B15D010					0	1683	0-30	990	73.6	45	1159
Module	EU6B10208035					5	1661	0-40	1265	94	55	130
Trim	6LBM1LI					15	1386	0-60	1341	99.7	65	87
Lumens	1345					25	993	0-90	1345	100	75	71
Efficacy	94.1 Lm/W	35	430	90-180	0	0	85	0				
SC	0.85	45	76	0-180	1345	100						
				D	FC	L	W					
		5.5'	56	4.6	4.6							
		7'	34	5.8	5.8							
		8'	26	6.6	6.6							
		9'	21	7.6	7.6							
10'	17	8.4	8.4									
12'	12	10	10									

WIDE (75° BEAM)		CANDLEPOWER DISTRIBUTION		CONE OF LIGHT		CANDELA TABLE		ZONAL LUMEN SUMMARY			LUMINANCE	
Test Number	P201213					Degrees Vertical	Canдела	Zone	Lumens	% Fixture	Average Candela Degrees	Average 0° Luminance
Housing	LD6B15D010					0	963	0-30	785	51.7	45	4835
Module	EU6B10208035					5	963	0-40	1207	79.5	55	1055
Trim	6LBW1LI					15	976	0-60	1510	99.4	65	151
Lumens	1519					25	913	0-90	1519	100	75	84
Efficacy	106.2 Lm/W	35	687	90-180	0	0	85	0				
SC	1.23	45	316	0-180	1519	100						
				D	FC	L	W					
		5.5'	32	6.6	6.6							
		7'	20	8.6	8.6							
		8'	15	9.8	9.8							
		9'	12	11	11							
10'	10	12.2	12.2									
12'	7	14.6	14.6									

SHALLOW (75° BEAM)		CANDLEPOWER DISTRIBUTION		CONE OF LIGHT		CANDELA TABLE		ZONAL LUMEN SUMMARY			LUMINANCE	
Test Number	P201212					Degrees Vertical	Canдела	Zone	Lumens	% Fixture	Average Candela Degrees	Average 0° Luminance
Housing	LD6B15D010					0	710	0-30	529	34.2	45	36260
Module	EU6B10208035					5	704	0-40	843	54.5	55	29687
Trim	6LBCS1MMS					15	666	0-60	1377	89	65	20068
Lumens	1546					25	596	0-90	1546	100	75	8318
Efficacy	110.4 Lm/W	35	502	90-180	0	0	85	749				
SC	1.16	45	393	0-180	1546	100						
				D	FC	L	W					
		5.5'	24	6.2	6.2							
		7'	15	8	8							
		8'	11	9.2	9.2							
		9'	9	10.4	10.4							
10'	7	11.6	11.6									
12'	5	13.8	13.8									

PHOTOMETRY

NARROW (30° BEAM)		CANDLEPOWER DISTRIBUTION		CONE OF LIGHT		CANDELA TABLE		ZONAL LUMEN SUMMARY			LUMINANCE	
Test Number	P201218					Degrees Vertical	Candela	Zone	Lumens	% Fixture	Average Candela Degrees	Average 0° Luminance
Housing	LD6B40D010					0	7716	0-30	2735	80.4	45	1928
Module	EU6B30508035					5	7196	0-40	3274	96.2	55	215
Trim	6LBN1LI					15	4183	0-60	3399	99.9	65	74
Lumens	3404					25	2017	0-90	3404	100	75	0
Efficacy	81.4 Lm/W					35	853	90-180	0	0	85	0
SC	0.53	45	126	0-180	3404	100						
		D	FC	L	W							
		5.5'	255	2.8	2.8							
		7'	158	3.6	3.6							
		8'	121	4.2	4.2							
		9'	95	4.6	4.6							
		10'	77	5.2	5.2							
		12'	54	6.2	6.2							

MEDIUM (50° BEAM)		CANDLEPOWER DISTRIBUTION		CONE OF LIGHT		CANDELA TABLE		ZONAL LUMEN SUMMARY			LUMINANCE	
Test Number	P201216					Degrees Vertical	Candela	Zone	Lumens	% Fixture	Average Candela Degrees	Average 0° Luminance
Housing	LD6B40D010					0	4794	0-30	2819	73.6	45	3303
Module	EU6B30508035					5	4731	0-40	3602	94	55	370
Trim	6LBM1LI					15	3946	0-60	3819	99.7	65	251
Lumens	3831					25	2829	0-90	3831	100	75	205
Efficacy	91.7 Lm/W					35	1226	90-180	0	0	85	0
SC	0.85	45	216	0-180	3831	100						
		D	FC	L	W							
		5.5'	159	4.6	4.6							
		7'	98	5.8	5.8							
		8'	75	6.6	6.6							
		9'	59	7.6	7.6							
		10'	48	8.4	8.4							
		12'	33	10	10							

WIDE (75° BEAM)		CANDLEPOWER DISTRIBUTION		CONE OF LIGHT		CANDELA TABLE		ZONAL LUMEN SUMMARY			LUMINANCE	
Test Number	P201214					Degrees Vertical	Candela	Zone	Lumens	% Fixture	Average Candela Degrees	Average 0° Luminance
Housing	LD6B40D010					0	2742	0-30	2236	51.7	45	13769
Module	EU6B30508035					5	2742	0-40	3439	79.5	55	3006
Trim	6LBW1LI					15	2778	0-60	4301	99.4	65	430
Lumens	4326					25	2600	0-90	4326	100	75	234
Efficacy	103.5 Lm/W					35	1957	90-180	0	0	85	0
SC	1.23	45	899	0-180	4326	100						
		D	FC	L	W							
		5.5'	91	6.6	6.6							
		7'	56	8.6	8.6							
		8'	43	9.8	9.8							
		9'	34	11	11							
		10'	27	12.2	12.2							
		12'	19	14.6	14.6							

SHALLOW (75° BEAM)		CANDLEPOWER DISTRIBUTION		CONE OF LIGHT		CANDELA TABLE		ZONAL LUMEN SUMMARY			LUMINANCE	
Test Number	P35144					Degrees Vertical	Candela	Zone	Lumens	% Fixture	Average Candela Degrees	Average 0° Luminance
Housing	LD6B40D010					0	2022	0-30	1506	34.2	45	17139
Module	EU6B30508035					5	2005	0-40	2399	54.5	55	14033
Trim	6LBCS1MMS					15	1897	0-60	3921	89	65	9486
Lumens	4403					25	1697	0-90	4403	100	75	3933
Efficacy	105.3 Lm/W					35	1430	90-180	0	0	85	348
SC	1.16	45	1119	0-180	4403	100						
		D	FC	L	W							
		5.5'	67	6.2	6.2							
		7'	41	8	8							
		8'	32	9.2	9.2							
		9'	25	10.4	10.4							
		10'	20	11.6	11.6							
		12'	14	13.8	13.8							



Sample Trash Enclosure Pictured: To use Like-Kind Materials.

- 5' Deep
- 8' Wide
- 5' Tall

Air Conditioner Enclosure (2 Each)



Street View



Facing North



Facing East



Facing South



Facing West



324 E Blue Bell Drive



2020 Main Ave South